

MAGICFX® CONFETTI GUN



PRODUCT CODE : MFX0370
VERSION : 1.0
DATE : 16.12.2013



1. FOREWORD

Congratulations! You have bought a great new product from MAGICFX®.

The MAGIC FX Confetti Gun is a new handheld product designed for safely shooting MAGIC FX confetti and streamer cannons. The Confetti Gun automatically detects the inserted cannons and displays if they are ready to be shot. The Confetti Gun is also equipped with a red laser for aiming.

MAGIC FX is a Dutch manufacturer of professional special effects machines and equipment. We have been experts in special effects since our establishment in 1995. All our products are made under the brand name MAGICFX® which by now has acquired a great reputation on account of its quality and reliability. All products are made in accordance with the European Machinery Directive. MAGIC FX manages the entire production process in-house, from the design stages and prototyping to production. In short, we cover everything from concept to ready-to-use products.

Moreover, MAGIC FX is Europe's largest supplier of high-quality and fireproof confetti products and streamers. Thanks to our very large stock levels, we can deliver quickly and at low prices.

MAGICFX® is used by special effects professionals all over the world and our products are distributed through a dealer network which covers more than 90 countries.





Congratulations and enjoy your purchase!

This manual describes the MAGICFX® Confetti Gun. The information in this manual is important for the proper and safe functioning of the Confetti Gun. If you are not familiar with the installation, operation, preventative maintenance etc. of the Confetti Gun then please read this user manual carefully from beginning to end. MAGIC FX also insists that all new users (operators, installers, maintenance workers and cleaners) receive a training course in which this user manual can serve as a starting point.

MAGIC FX advises that the original of this user manual, including appendices, is kept at a safe and central place. It is best that another original or copy is kept close to the Confetti Gun at the workplace.

If you are familiar with these matters, then you can use this manual as a work of reference.

The following standard markings are used in this manual for drawing attention to certain subjects or actions.

	<p>TIP: Gives you suggestions and advice regarding easier or more convenient ways to carry out certain tasks.</p>
	<p>PLEASE NOTE: A comment with additional information: alerts you to certain problems.</p>
	<p>CAUTION: The machine can be damaged if you do not follow the procedures carefully.</p>
	<p>DANGER WARNING: You can get (seriously) hurt if you do not carefully carry out the procedures.</p>

CONTENTS

1.	FOREWORD	1
2.	INTRODUCTION	3
2.1	DESCRIPTION AND APPLICATION OF THE CONFETTI GUN	3
2.2	NECESSARY ACCESSORIES.....	3
2.3	CANNONS.....	3
3.	SAFETY	5
3.1	INTRODUCTION	5
3.2	GENERAL SAFETY RULES.....	5
3.3	WARNINGS.....	5
3.4	LIPO BATTERY	7
4.	PARTS	8
5.	ACCESSORIES.....	9
6.	PREPARATIONS	9
7.	INSTALLATION	9
8.	USAGE	11
9.	SWITCHING OFF	12
10.	CE MARKING.....	13
11.	DECLARATION OF CONFORMITY.....	14
12.	TROUBLESHOOTING	15
13.	TECHNICAL SPECIFICATIONS	15
14.	MAINTENANCE	15
15.	GUARANTEE	15

2. INTRODUCTION

2.1 DESCRIPTION AND APPLICATION OF THE CONFETTI GUN

The Confetti Gun is a confetti shooting system which has been specially developed to easily shoot electric cannons.

The Confetti Gun can be used with electric confetti cannons as well as with electric streamer cannons.

As the Confetti Gun can be used in various ways, it is important to read this user manual carefully from beginning to end before you start operating the machine.

Any use other than that described above excludes your supplier from any liability.



2.2 NECESSARY ACCESSORIES

The following parts belong to the Confetti Gun:

<p>Manual</p>	<p>MFX0308 – Power cable</p>	<p>Electric Cannon</p>

Table 2.1

2.3 CANNONS

The Confetti Gun offers the possibility to work with approved electric confetti and streamer cannons. The Confetti Gun is not suitable for cannons other than those described below.

<p>40cm Electric cannon</p>	<p>80cm Electric cannon</p>	<p>Other confetti cannons</p>

Table 2.2

The following types of electric cannons are possible:







TYPE CANNON	CONTENT	CANNON LENGTH	OUTPUT
	CONFETTI (150g)	40CM	5M
	STREAMERS (150g)	40CM	12M
	CONFETTI (300g)	80CM	12M
	STREAMERS (300g)	80CM	20M

Table 2.3

All pre-filled cannons are for one-time use only.

	DANGER WARNING: Metallic products are heavier and will therefore have a larger output.
	DANGER WARNING: The electric cannons contain pressure containers which fire off the confetti/streamers under a lot of pressure. Therefore always make sure there is a free shooting range.

3. SAFETY

3.1 INTRODUCTION

The Confetti Gun has been designed and constructed in such a manner that it can be used safely. This applies to the use, the circumstances and the regulations as described in this documentation. Reading this documentation and following the instructions are therefore necessary for everyone who is authorised to work with the Confetti Gun.

The Confetti Gun must be placed and used in surroundings that preferably:

- Have a reasonably stable temperature of between 0 and 30°C.
- Have a relative humidity degree of no more than 75%.
- Are reasonably free of dust, corrosive gases and high concentrations of organic vapours.
- Are not situated in the vicinity of a source of vibration.

3.2 GENERAL SAFETY RULES

- Only use the Confetti Gun if there are no people, animals or other objects in the direction of the electric cannons within the output distance. The shooting direction is the direction in which the electric cannons in the Confetti Gun are pointed. The output distance depends on the content and length of the electric cannons.
- Make sure that children, unauthorised people and animals do not obtain access to the Confetti Gun!
- Safety devices may not be removed or disabled.
- All required safety devices must be in good condition and function properly.
- Ensure sufficient lighting of the surroundings.
- Keep the workplace clean.
- Only authorised persons may carry out work with the Confetti Gun.

3.3 WARNINGS



Warning texts have been attached to the Confetti Gun. With regard to these, the following rules apply:

- These texts may not be removed or damaged. The operator must regularly check if this is the case.
- The operator must ensure that the texts are and remain clearly visible and legible.

	DANGER WARNING: One must replace texts or signs if these are absent, damaged or illegible.
---	---

Sign and explanation	Photo
<div data-bbox="395 226 595 421" data-label="Image"> </div> <p data-bbox="309 459 679 486">PIC 616 Follow the instructions</p> <p data-bbox="209 521 774 607">The operator must be told that he/she may only operate the Confetti Gun after reading the user manual.</p> <p data-bbox="209 645 767 763">A warning is given for this by means of the command sign of PIC 616. This sign should be attached to the type sign. See also the added photo.</p>	<div data-bbox="837 383 1378 674" data-label="Image"> </div>

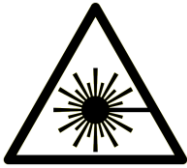
Sign and explanation	Photo
<div data-bbox="395 958 595 1122" data-label="Image"> </div> <p data-bbox="316 1173 671 1200">PIC 307 Danger: high voltage</p> <p data-bbox="209 1236 774 1355">A warning must be given about the machine's high voltage by using the caution sign PIC 307. This sign must be attached to the Confetti Gun. See also the added photo.</p>	<div data-bbox="837 1099 1378 1391" data-label="Image"> </div>

Sign and explanation	Photo
<div data-bbox="400 257 587 423" data-label="Image"></div> <p data-bbox="347 456 639 486">PIC 309 Laser Radiation</p> <p data-bbox="209 524 770 645">A warning must be given about the machine's laser by using the caution sign PIC 309. This sign must be attached to the Confetti Gun. See also the added photo.</p>	<div data-bbox="876 385 1315 613" data-label="Image"></div> <div data-bbox="863 658 1326 799" data-label="Image"></div>

3.4 LIPO BATTERY

The Confetti Gun is equipped with a lithium polymer (LiPo) battery which enables the Confetti Gun to be used without constant power supply.

4. PARTS

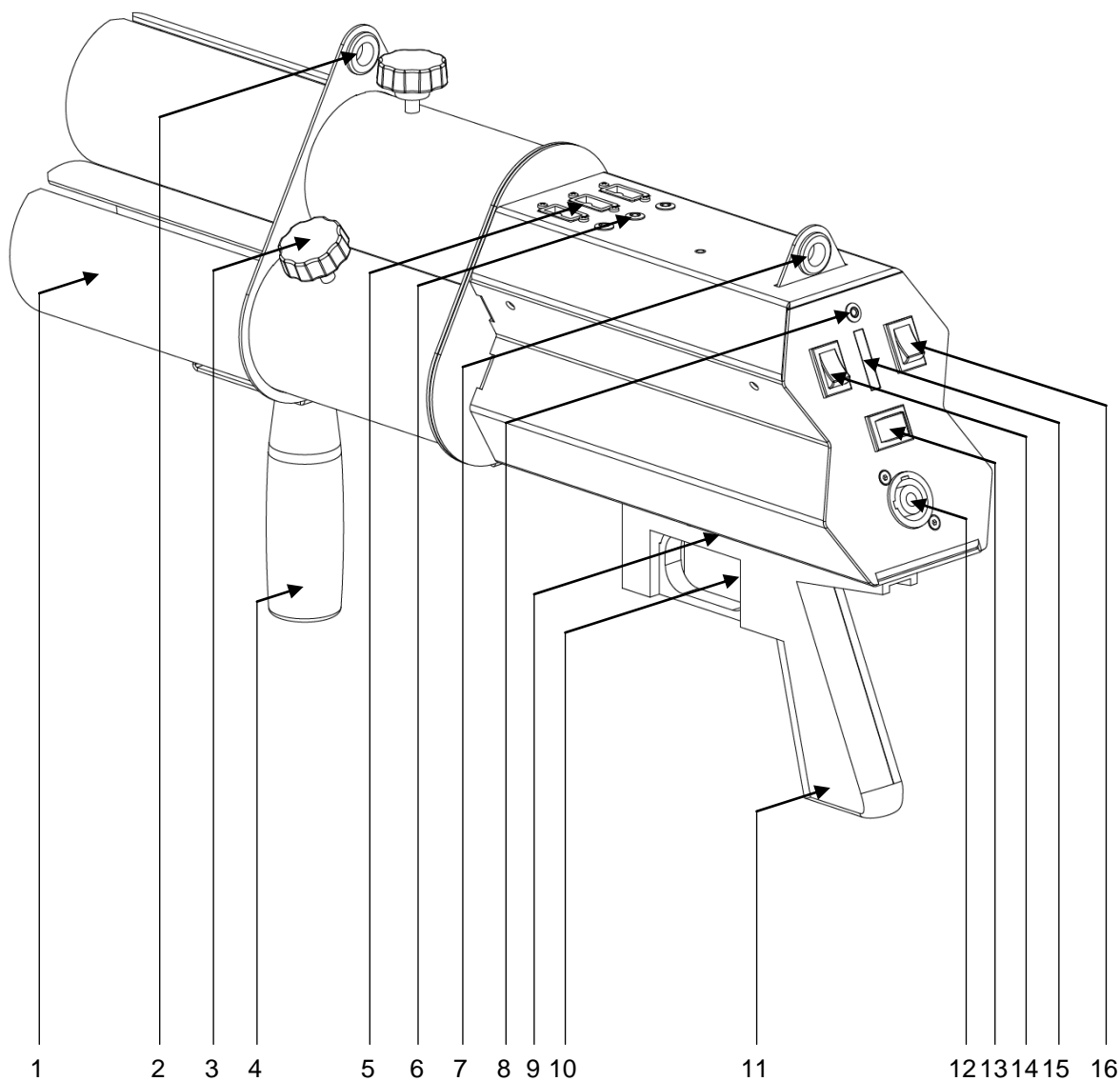

- | | |
|------------------------|-----------------------|
| 1. Cannon holders | 9. Safety catch |
| 2. Shoulder strap hole | 10. Trigger |
| 3. Cannon nut | 11. Trigger handle |
| 4. Handle | 12. Power input |
| 5. Cannon connectors | 13. Mode switch |
| 6. Indicator LED's | 14. Power switch |
| 7. Shoulder strap hole | 15. Battery indicator |
| 8. Charging indicator | 16. Laser switch |

5. ACCESSORIES



Table 5.1



You can order these parts and accessories from:

<p>MAGIC FX B.V. Schouwrooij 27 NL-5281 RE BOXTEL The Netherlands T. +31(0)411 63 50 13 F. +31(0)411 63 50 12 W. http://www.magicfx.eu E. info@magicfx.eu</p>	
---	--

6. PREPARATIONS

Unpack the Confetti Gun. Dispose of the packaging material without harming the environment. Inspect the machine for any damage. If damage is noticed this must be reported to MAGIC FX.

7. INSTALLATION

	<p>CAUTION: The machine can be damaged if you do not follow the procedures carefully.</p>
	<p>WARNING: The MAGICFX® Confetti Gun may only be installed by adults and authorised persons.</p>

Prepare the Confetti Gun for use as follows:

1.

	<p>You need to charge the Confetti Gun first.</p> <p>To charge the Confetti Gun you need a powerCON cable. Connect the powerCON to the POWER INPUT and the other end to a power source (230V~ 50/60Hz)</p> <p>The CHARGING BATTERY LED will light up when the battery is charged.</p>
---	--

2.



When the Confetti Gun is fully charged the LED CHARGING BATTERY is green. U can now disconnect the Confetti Gun.



For the maximum battery life leave the Confetti Gun plugged in for 8 hours.

3.



Place the electric cannons in the cannon holder.



The electric cannon can detach itself through the pressure that is released during the shooting. Therefore always use the Cannon Clamp to secure it to the Confetti Gun.

4.



Secure the electric cannons with a screw nut which is situated on the sides of the holders.





Never turn the screw nuts tighter than necessary. This can damage the pressure pattern in the electric cannon.

5.



Plug in the electric cannon connector in the right way into the connector on top of the Confetti Gun. This connector has a slot which insures that the connector can be inserted in only one way.

8. USAGE

	<p>TIP: Gives you suggestions and advice regarding easier or more convenient ways to carry out certain tasks.</p>
	<p>CAUTION: The machine can be damaged, if you do not follow these procedures carefully.</p>
	<p>DANGER WARNING: The MAGICFX® Confetti Gun may only be installed by adults and authorised persons.</p> <p>The Confetti Gun may only be operated if all parts are completely and correctly installed/connected.</p>

For using the Confetti Gun take the following steps:

1.



Turn on the Confetti Gun, the indicator LED's will all blink twice to test if the LED's are working. If there are any cannons plugged in and the gun is in single shot mode the left most LED starts blinking indicating the cannon is ready to be shot. In full shot mode all LED's where a cannon is connected start to blink.

2.



If the safety pin is enabled you can remove it by pushing the pin to the left. To restore the safety, push the pin back to the right side.

3.



Pull the trigger to shoot the first or all the cannon's depending on which mode the Confetti Gun is. Repeat to shoot all the cannon's.



Make sure that you only shoot when there are no people, animals or objects in the shooting range of the cannons.

9. SWITCHING OFF

To switch off the Confetti Gun, take the following steps:

1.



Put the Confetti Gun in the safe mode by pushing the safety pin to the right.

2.



Turn off the Confetti Gun.

3.



Remove the cannon's from the Confetti Gun.





Before storing the Confetti Gun charge the Confetti Gun till it is fully charged to get the maximal battery life.



For the maximum battery life leave the Confetti Gun plugged in for 8 hours.

10. CE MARKING

	<p>PLEASE NOTE: We presume that you, your employees and others who use or come into contact with the machine are familiar with how the machine must be dealt with. This includes the correct use, maintenance and repair of the machine as described in this user manual. This also means that the employees are familiar with the use of machines through training or experience.</p>
	<p>DANGER WARNING: Only use the Confetti Gun in accordance with the regulations and instructions in this manual. Consult MAGIC FX in case of doubt.</p>

Disclaimers:

MAGIC FX B.V. excludes liability for unsafe situations, accidents and damage that are the result of:

- Disregard for the warnings or regulations as set out on the Confetti Gun or in this documentation.
- Use for other purposes or under other circumstances than those set out in this documentation.
- Alterations to the Confetti Gun. This also includes the use of replacement parts other than the original ones.
- Insufficient maintenance.
- Unauthorised removal of safety caps and/or safeguards.
- Incompetent operation of the machine.

MAGIC FX B.V. is not liable for any consequential loss in the event of a Confetti Gun breakdown.

© Copyright 2013

All rights are reserved. Nothing from this manual may be duplicated, or kept in an automated data file, or made public, or in any form or manner, whether electronically, mechanically, by photocopying, by incorporation, or in any other manner duplicated without the permission of MAGIC FX B.V.

MAGIC FX at all times retains the right to make alterations without the direct knowledge of the client. The contents of this user manual can also be changed.

Please contact the technical department of your supplier for extra information with regard to, for example, maintenance and repair. This user manual has been drawn up with the utmost care. MAGIC FX cannot be held responsible for any mistakes made in this publication or for any consequences thereof.

11. DECLARATION OF CONFORMITY

DECLARATION OF CONFORMITY
(according to Annex II.1.A of the Machinery Directive)



Concerning the Machinery Directive.
We; MAGIC FX B.V.
Schouwrooij 27
5281 RE Boxtel
The Netherlands

State under personal responsibility:
We are the manufacturer of the product:

MFX0370 - MAGICFX[®] Confetti Gun

to which this statement relates and which is in accordance with the provisions of the following Directive(s):

- Machinery Directive 2006/42/EC
- Low Voltage Directive 2006/95/EC
- EMC Directive 2004/108/EG

The following harmonising standards have been applied:

- NEN-EN-ISO 12100
- NEN-EN-ISO 60204-1

Place : Boxtel
Date : 15-10-2012

Name: MAGIC FX

A handwritten signature in black ink, consisting of a large, stylized 'B' followed by a series of loops and a long horizontal stroke extending to the right.

Director: B. Veroude

12. TROUBLESHOOTING

- **The machine does not turn on.**

Charge the Confetti Gun.

- **A cannon does not work.**

Always use MAGIC FX cannons! Check if the connector of the cannon is properly connected. If so, exchange the cannon with another and see if this one works.

- **The output is not 10 to 12 VDC**

The electronics in the Confetti Gun will fully be activated when a load like a cannon is attached.

- **The Confetti Gun is still malfunctioning after troubleshooting**

Always contact your dealer or the technical service of MAGIC FX first in case of uncertainties, questions about the Confetti Gun works or other issues with regard to the Confetti Gun.

13. TECHNICAL SPECIFICATIONS

Measurements and weight	Length:	272mm (10.7")
	Width:	145mm (5.5")
	Height:	264mm (10.4")
	Weight:	4.6 Kg (10.2lbs.) without cannons
Power	Input:	AC 230V~50-60Hz
	Output:	DC \pm 12V
	Fuse:	T15A 250V 6,3x32mm
	Battery internal:	Lithium Polymer Battery

Design and product specifications can be changed without prior notification.

14. MAINTENANCE

To achieve the maximum service life of the Confetti Gun you must regularly clean the Confetti Gun and test if it is working correctly.

Should the Confetti Gun doesn't work for some reason then please contact MAGIC FX.

	<p>DANGER WARNING: Do not replace parts yourself; always consult MAGIC FX if necessary.</p>
---	--

15. GUARANTEE

A manufacturer's guarantee of 3 years applies to the MAGIC FX Confetti Gun.

- The guarantee expires if the Confetti Gun is used for improper purposes and for applications which are not stated in this manual.
- The guarantee also expires if the machine is used incorrectly or in violation of the regulations.
- The guarantee expires if the machine is altered without permission from the supplier.